

Article number: 2310431033
Description: E+G Levelling elements
LX.40-SW17-M8X20

Measures

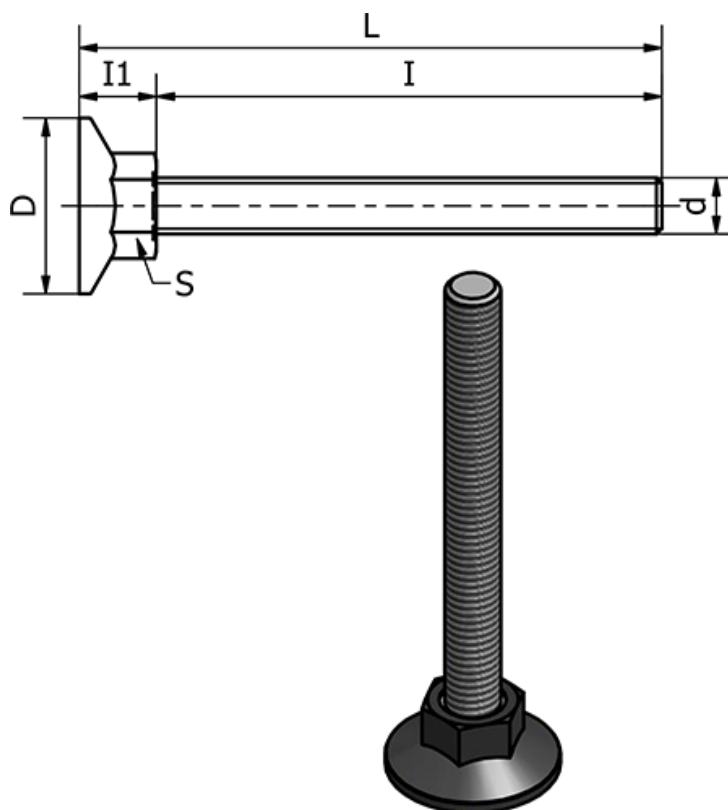

d	= M8
D	= 40
I	= 20
I1	= 13
L	= 32.5
S	= 17
Static load in (N)	= 2500
Type	= Forzinket

Weight (g) = -